

Article number: 604132036020

Description: Taper bored timing belt pulley  
HTD 36 8M 20 TL 1610

## Measures

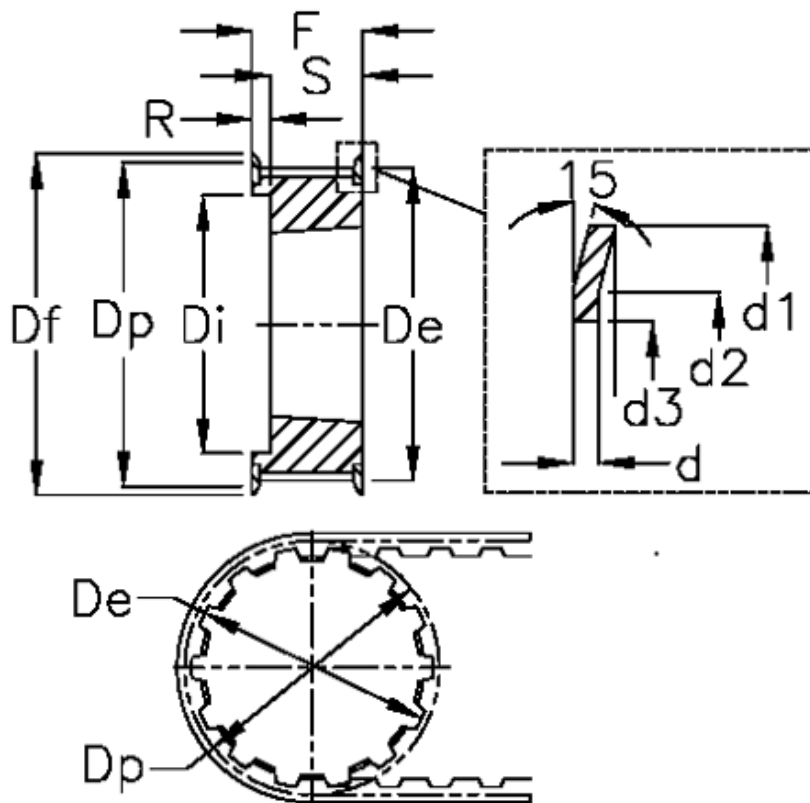

d = 1.5	F = 28	Weight = 0.68
d1 = 97	Flange type = F33	Width = 20
d2 = 93.8	For bushing = 1610	
d3 = 83	Max bore = 42	
De = 90.3	r = 3	
Df = 97	S = 25	
Di = 68	Tooth number = 36	
Dp = 91.67	Type = 8M	